

HAKKO FR-802

SMD Rework Station

Instruction Manual

Thank you for purchasing the HAKKO FR-802 SMD rework station.
 This unit features digital control and display of hot air temperature.
 Please read this manual before operating the HAKKO FR-802.
 Keep this manual readily accessible for reference.

1. PACKING LIST AND PART NAMES

Please check to make sure that all items listed below are included in the package.

HAKKO FR-802 station	1	FP pick-up wire (L)	1
Handpiece	1	FP pick-up wire (S)	1
Control card	1	Instruction manual	1
Card chain	1		
Power cord	1		
FP pick-up	1		

* This product does not include a nozzle. A large selection of nozzles is available for the HAKKO FR-802. Select the nozzle or nozzles suitable for the work to be performed.

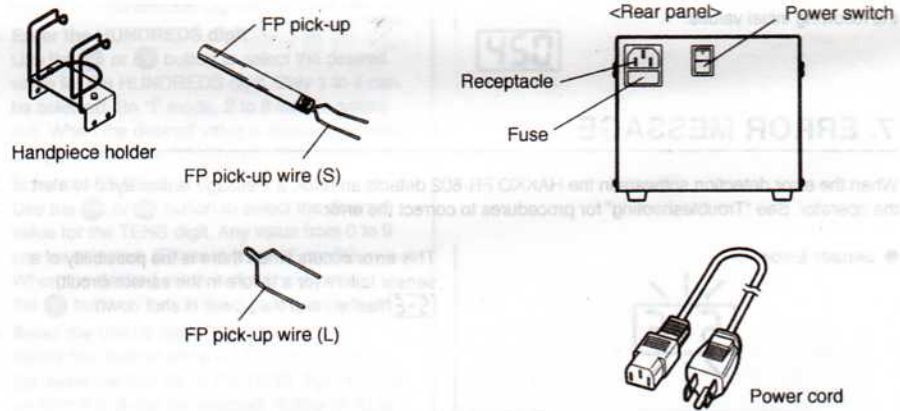
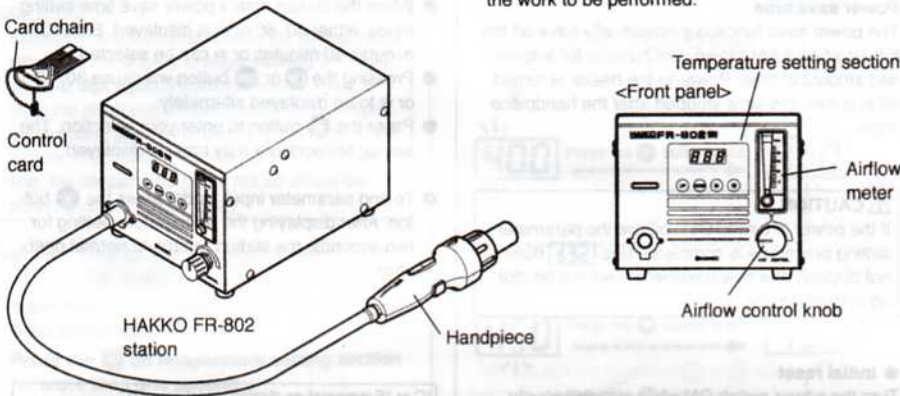

2. SPECIFICATIONS

Name	HAKKO FR-802
Power consumption	100V-310W 110V-360W 120V-430W 220V-570W 230V-630W 240V-680W

● Station

Power consumption	30W (standby power consumption) 100-120V 4W 220-240 4W
Capacity (Air blow)	5 - 20 l/min (maximum)
Control temperature	100 - 450°C (200 - 840°F) (Sensor)
Outer dimensions	160 (W) × 145 (H) × 230 (D) mm
Weight	4.3kg

● Handpiece

Power consumption	100V-280W 110V-330W 120V-400W 220V-540W 230V-600W 240V-650W
Total length (w/o cord)	200 (L) mm
Weight (w/o cord)	200g

* This product is protected against electrostatic discharge.
 * Specifications and design are subject to change without notice.

3. WARNINGS, CAUTIONS AND NOTES

Warnings and cautions are placed at critical points in this manual to direct the operator's attention to significant items. They are defined as follows:

WARNING: Failure to comply with a WARNING may result in serious injury or death.

CAUTION: Failure to comply with a CAUTION may result in injury to the operator, or damage to the items involved. Two examples are given below.

EXAMPLE: AN EXAMPLE is given to demonstrate a particular procedure, point or process.

● Be sure to comply with the following WARNINGS and CAUTIONS for your safety.

WARNING

● To avoid damage to the unit, do not turn the power switch OFF until the pump (until **P-5** appears on the display.) stops automatically by cooling down after use.

CAUTION

When the power is ON, the temperature of the hot air and the nozzle ranges from 100 to 450°C (200 to 840°F). To avoid injury to personnel or damage to items in the work area, observe the following:

- Do not direct the hot air toward personnel or touch the metal parts near the nozzle.
- Do not use the product near combustible gases or flammable materials.
- Advise those in the work area that the unit can reach very high temperatures and should be considered potentially dangerous.
- Turn the power off when no longer using the HAKKO FR-802 or when leaving it unattended.
- Before replacing parts or storing the unit, allow the unit to cool and then turn the power OFF.

● To prevent accidents and failures, be sure to take the following precautions:

- Do not strike the handpiece against hard surfaces or otherwise subject it to physical shock.
- Be sure the unit is grounded. Always connect power to a grounded receptacle.
- Do not disassemble the pump.
- Do not modify the unit.
- Use only genuine HAKKO replacement parts.
- Do not bend or damage the control card. If the card does become damaged, do not force the card into the station slot.
- Do not wet the unit or use the unit with wet hands.
- Remove power cord by holding the plug - not the wires.
- Make sure the work area is well ventilated.
- The HAKKO FR-802 is not intended for use by children or infirm persons without supervision.
- Children should be supervised to ensure that they do not play with the HAKKO FR-802.

4. PREPARATION: ASSEMBLY AND ELECTRICAL CONNECTION

A. Station assembly

● **Attach the handpiece holder.**

Remove the handpiece holder mounting screw from the side of the station. Attach the handpiece holder to the station. (Figure 1)
(The handpiece holder can be installed on either the left or right side.)

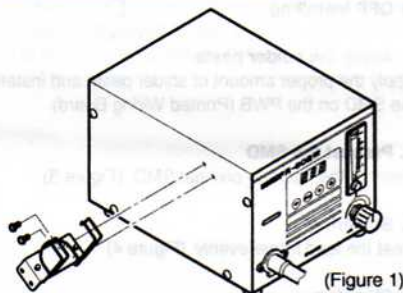

B. Handpiece assembly

● **Attach the nozzle.**

Loosen the nozzle mounting screw. Attach the nozzle as shown in the drawing. (Figure 2)

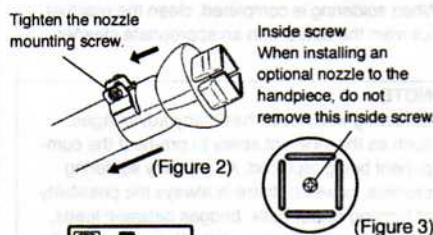

C. Electrical connection and power ON

1. Insert the power cord into the receptacle on the rear panel of the station. (Figure 4)
2. Place the handpiece on the holder. (Figure 5)
3. Plug the other end of the power cord into a grounded wall socket.
4. Turn the power switch ON.

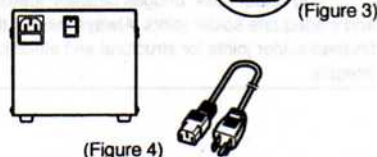

CAUTION
This product is protected against electrostatic discharge. Be sure to use a grounded wall socket.

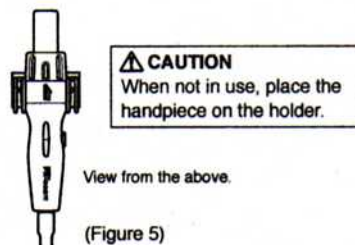

5. OPERATION

● Air Blow

1. Start

Press the Start button on the handpiece to start the flow of air. The hot air blows from the tip of the nozzle, and the temperature is controlled according to the temperature setting.

2. Stop

Press the Start switch again. Power to the heater is shut off and cooling begins. When the temperature falls to 100°C (200°F), the air stops blowing and the temperature display reads **P-5**.

NOTE:

If power is turned off after use, there will be no cool-down. Automatic cool-down is only initiated by the second activation of the Start switch.

● Setting/Changing the Temperature

CAUTION

The temperature setting range is 100 to 450°C (200 to 840°F).

- Attempt to enter a value outside the setting range will cause the display to begin flashing the HUNDREDS digit again. Reenter a correct value.
- Both the displayed temperature and the temperature setting are the temperature detected at the sensor. (Even with the same temperature setting, the temperature of the hot air differs depending on the nozzle size.)

Example: Change the temperature setting from 300 to 450°C.

1. Insert the control card into the slot in the front of the unit.

2. Press the **⊛** on temperature setting section for more than one second.

- The station goes into temperature setting mode and the HUNDREDS digit flashes on the display, indicating that the HUNDREDS digit can be entered.

3. Enter the HUNDREDS digit

- Use the **⬆** or **⬇** button to select the desired value for the HUNDREDS digit. Only 1 to 4 can be selected. (In °F mode, 2 to 8 can be selected). When the desired value is displayed, press the **⊛** button. The TENS digit begins to flash.

4. Enter the TENS digit

- Use the **⬆** or **⬇** button to select the desired value for the TENS digit. Any value from 0 to 9 can be selected. (Either in °C or °F mode). When the desired value is displayed, press the **⊛** button. The UNITS digit begins to flash.

5. Enter the UNITS digit

- Select the desired value for the UNITS digit in the same manner as for the TENS digit. Any value from 0 to 9 can be selected. (Either in °C or °F mode).
- Press the **⊛** button, then **SEE** is displayed and the new setting is stored.
- The temperature setting is stored in the memory. Heater control begins after the new temperature setting is displayed.

CAUTION

Do not stop the hot air by turning the power switch OFF.

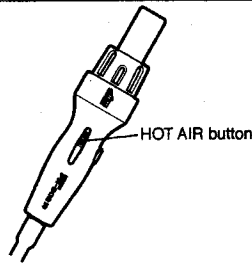

WARNING

To avoid damage to the equipment, do not turn the power switch OFF until **P-5** appears on the display.

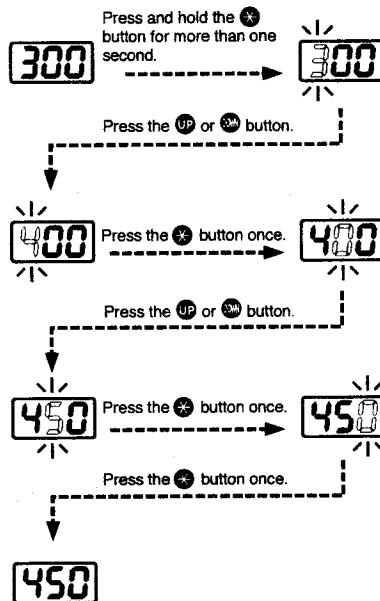

CAUTION

If the power is turned OFF before the temperature setting procedure is completed (the **SEE** does not display), the new setting value will not be stored in the memory.

5. OPERATION

● How to enter the offset value into the HAKKO FR-802

NOTE:

The temperature of the hot air differs depending on the nozzle size. It is available to set the offset value of the temperature.

Example: If the measured temperature is 410°C and the set temperature is 400°C, the difference is 10°C (need to be decrease by 10°C). So, enter -10 as the offset value.

1. Insert the control card into the slot in the front of the unit.

2. Press **#** button on the temperature setting section for more than one second.

- The station is in the offset value setting mode. The HUNDREDS digit will begin to flash.
- This will set the station to offset value entry mode.

3. Enter the offset value.

- The allowable ranges for offset values are -50 to +50°C (in °F mode, -90 to +90°F).

⚠ CAUTION

During the offset value entry mode, the nozzle temperature is controlled in accordance with the current offset value.

a) Entering the HUNDREDS digit

- Press the **Up** or **Down** button to set the desired value. Only 0 (for positive value) or - (for negative value) can be selected (either in °C or °F mode). When the desired value is displayed, press the ***** button to enter. The TENS digit will begin to flash.

b) Entering the TENS digit

- Press the **Up** or **Down** button to set the desired value. Only 0 to 5 can be selected (in °F mode, 0 to 9). When the desired value is displayed, press the ***** button to enter. The UNITS digit will begin to flash.

c) Entering the UNITS digit

- Press the **Up** or **Down** button to set the desired value. Any value from 0 to 9 can be selected. (Either in °C or °F mode). When the desired value is displayed, press the ***** button, then the **SEE** is displayed and the new offset value is now entered into the system memory and heater control will begin.

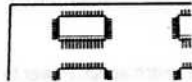

NOTE:

Place a K thermocouple of the thermometer as shown to measure the nozzle temperature. The distance from the nozzle is 1mm (0.04 in.)

Insert the card.

P-5

Press the **#** button and hold for one second.

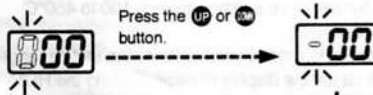

Press the ***** button once.

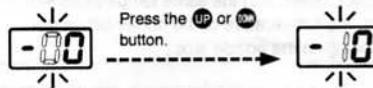

Press the ***** button once.

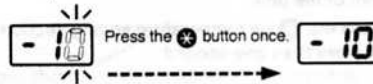

NOTE:

When the **#** button is pressed the current offset value is displayed for two seconds, then returns to show the temperature setting.

5. OPERATION

● QFP Removing

1. Set the temperature and adjust the air flow control knob.

Adjust the flow rate of the hot air while watching the airflow meter. Wait until the temperature is stable.

⚠ WARNING

Use the HAKKO FR-802 at an air flow level of 5 l/min or more.

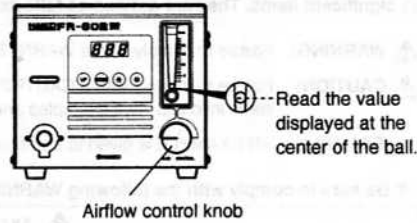

Airflow control knob

2. Place the FP pick-up under the IC lead.

Slip the FP pick-up wire under the IC lead. (Figure 1) If the width of the IC does not match the size of the FP pick-up, adjust the width of the pick-up by squeezing the wire. In case of PLCC (Plastic Lead Chip Carrier) or small components such as chip resistors, remove by using tweezers, etc.

3. Heating.

Hold the handpiece so that the nozzle is located directly over, but not touching the IC, and allow the hot air to melt the solder. Be careful not to touch the leads of the IC with nozzle.

4. Remove the IC.

Once the solder has melted, remove the IC by lifting the FP pick-up. (Figure 2)

5. Remove any remaining solder.

After removing the IC, remove remaining solder with a soldering iron and wick or desoldering tool.

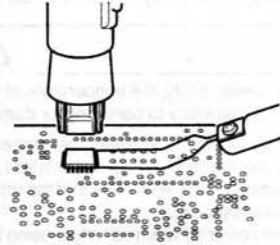

(Figure 1)

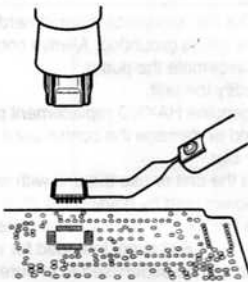

(Figure 2)

● QFP Installing

1. Apply the solder paste.

Apply the proper amount of solder paste and install the SMD on the PWB (Printed Wiring Board).

2. Preheat the SMD

Refer to the figure to preheat SMD. (Figure 3)

3. Soldering

Heat the lead frame evenly. (Figure 4)

4. Cleaning

When soldering is completed, clean the residual flux from the board with an appropriate cleaner.

NOTE:

Soldering with hot air has many advantages, such as the inherent ability to pre-heat the component being replaced. As with any soldering process, however, there is always the possibility of forming solder balls, bridges between leads, and inadequate solder joints. Always inspect the finished solder joints for structural and electrical integrity.

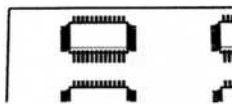

(Figure 3)

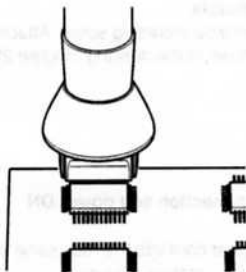

(Figure 4)

6. PARAMETERS/INITIAL RESETTING (INITIALIZATION)

● Entering the parameters

1. °C (Celsius) or °F (Fahrenheit) temperature display selection

Power save time

The power save function automatically turns off the hot air when it has blown continuously for a specified amount of time. Power to the heater is turned off and then the air is stopped after the handpiece cools.

⚠ CAUTION

If the power is turned OFF before the parameter setting procedure is completed (the **S-E** does not display), the new parameters will not be stored in the memory.

● Initial reset

Turn the power switch ON while simultaneously pressing the **UP**, **DOWN**, **STOP** and buttons on the temperature setting section. The station will be reset to the following initial values:

The HAKKO FR-802 has the following two parameters:

- 1) °C or °F temperature display selection
- 2) Power save time (select 30 or 60 minutes)

Once the station enters parameter mode, set the parameters in the order shown below. After all the parameters have been set, normal operation will be resumed.

1. Turn the power switch OFF.
2. Insert the control card into the slot in the unit.
3. Press and hold down the **UP** and **DOWN** buttons on the temperature setting section simultaneously and then turn the power switch ON.
4. Continue holding down both buttons until the display shows **C** (for Celsius) or **F** (Fahrenheit). When the display shows **C** or **F**, the station is in the parameter input mode.

- Press the **UP** or **DOWN** button will cause **C** or **F** to be displayed alternately.
- Press the **STOP** button to select the scale. The power save time may now be entered.
- When the station enters power save time setting mode, either 30, 60 or ∞ is displayed. Either 30 minutes, 60 minutes or ∞ can be selected.
- Pressing the **UP** or **DOWN** button will cause 30, 60 or ∞ to be displayed alternately.
- Press the **STOP** button to enter your selection. The sensor temperature may now be displayed.
- To end parameter input mode, press the **STOP** button. After displaying the temperature setting for two seconds, the station returns to normal operation

°C or °F temperature display selection	°C
Power save time	30 minutes
Temperature setting	300°C

7. ERROR MESSAGE

When the error detection software in the HAKKO FR-802 detects an error, a message is displayed to alert the operator. See "Troubleshooting" for procedures to correct the error.

● Sensor Error



This error occurs when there is the possibility of a sensor failure (or a failure in the sensor circuit). **S-E** flashes and the power is shut down.

● Heater Error



This error occurs when the temperature of the hot air is falling even though the heater is on. **H-E** flashes to indicate the possibility of a heater failure.